

NOTES:

1. ROHS COMPLIANT
2. STORAGE TEMPERATURE: -50°C TO +125°C
3. COMPLIANCE TO J-STD:
  - A. J-STD-002: SOLDERABILITY AT 245°C REFLOW PROFILE
  - B. J-STD-020: LEVEL 1, NO MOISTURE SENSITIVE
  - C. J-STD-075: R7, 245°C MAXIMUM THROUGH REFLOW SOLDER
4. TO ORDER TAPE & REEL PACKAGING ADD A "T" SUFFIX TO THE PART NUMBER(i.e HXXXXXXNL BECOMES HXXXXXXNLT).

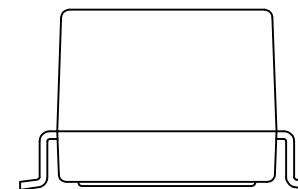
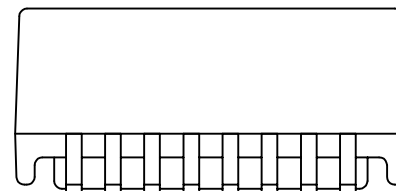
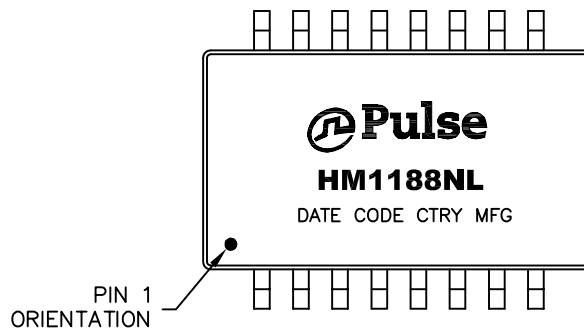

FINAL OUTLINE

© Copyright, 2016. Pulse Electronics Corp. All rights reserved. Pulse confidential & proprietary. (09/05/16)

PRODUCT DESCRIPTION  
MDL,SIN,100D,1:1,SM,TU

TLA DRAWING  
HM1188NL-10

PS DRAWING  
PS-2005.001-F

SHEET  
1 OF 3

PART NO.  
HM1188NL

DATASHEET REV.  
E

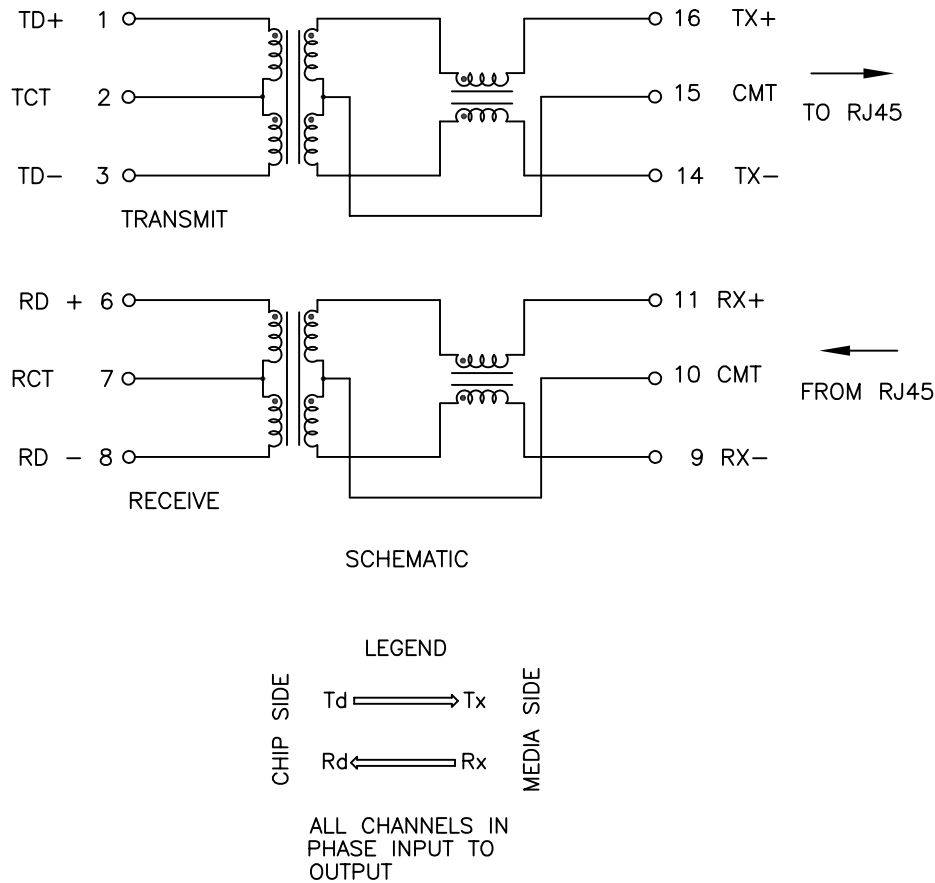

ELECTRICAL CHARACTERISTICS AT +25°C UNLESS OTHER SPECIFIED  
MEETS IEEE 802.3 SPECIFICATION

PARAMETER	SPECIFICATIONS	
OPERATING TEMP	-40°C TO +105°C	
TURNS RATIO	1 : 1 ±2%	
POLARITY	PER SCHEMATIC	
INDUCTANCE (OCL) (MEDIA SIDE, -40°C~+105°C)	350 uH MIN (MEASURED AT 100 KHz, 100 mVRMS) (AND WITH 8 mA DC BIAS)	
INSERTION LOSS	1-100 MHz	125 MHz
	-1.0 dB MAX	-3.0 dB MAX
RETURN LOSS Z <sub>OUT</sub> = 100 OHMS	5 MHz	30-80 MHz
	-18 dB MIN	-16 + 26LOG <sub>10</sub> (f/30 MHz) dB MIN
CROSSTALK (TX-RX)	1 MHz	5-100 MHz
	-62 dB MIN	-45 + 21LOG <sub>10</sub> (f/30 MHz) dB MIN
DIFFERENTIAL TO COMMON MODE REJECTION	5-200 MHz	
	-50 + 17LOG <sub>10</sub> (f/5 MHz) dB MIN	
INPUT - OUTPUT ISOLATION	1500 VAC MINIMUM FOR 60 SECONDS	

© Copyright, 2016. Pulse Electronics Corp. All rights reserved. Pulse confidential & proprietary. (09/05/16)

PRODUCT DESCRIPTION  
MDL,SIN,100D,1:1,SM,TU

TLA DRAWING  
HM1188NL-10

PS DRAWING  
PS-2005.001-F

SHEET  
2 OF 3

PART NO.  
HM1188NL

DATASHEET REV.  
E

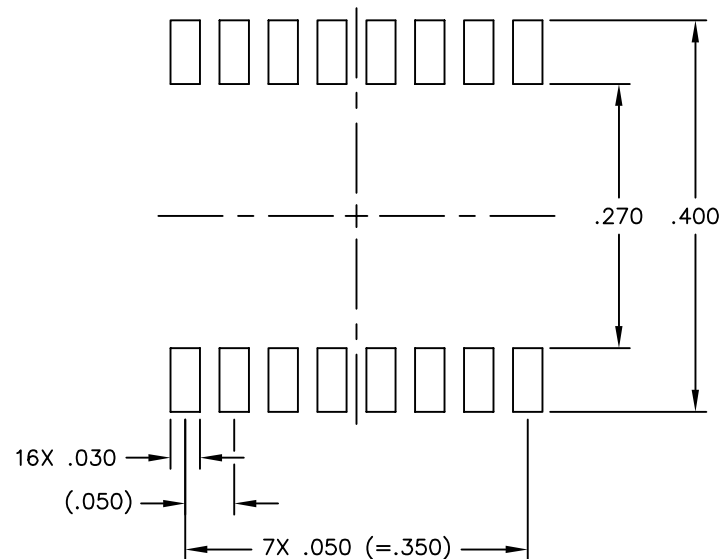
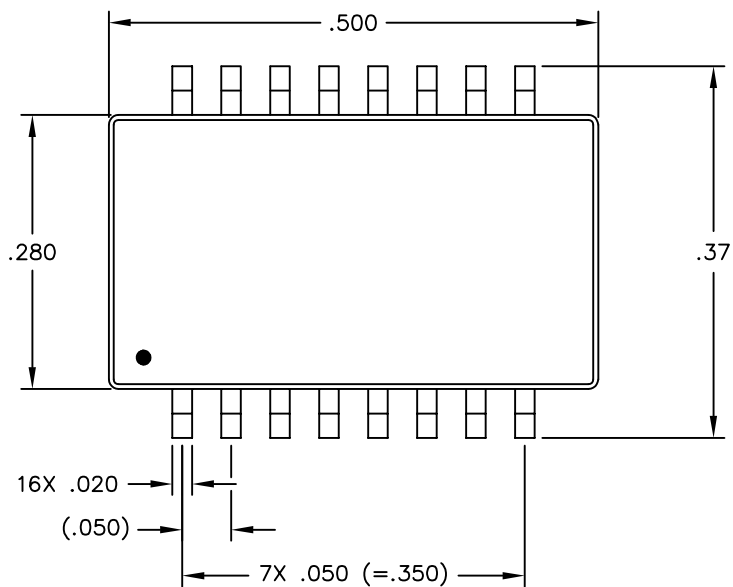

SUGGESTED LAND PATTERN

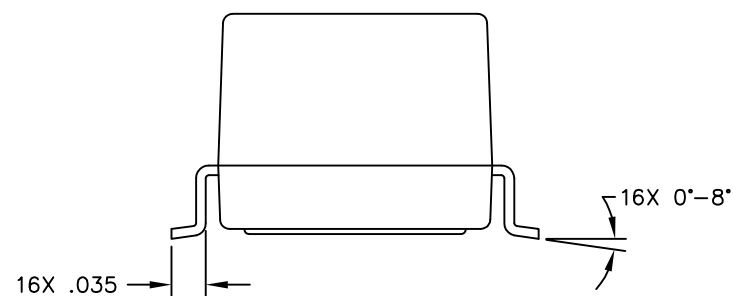
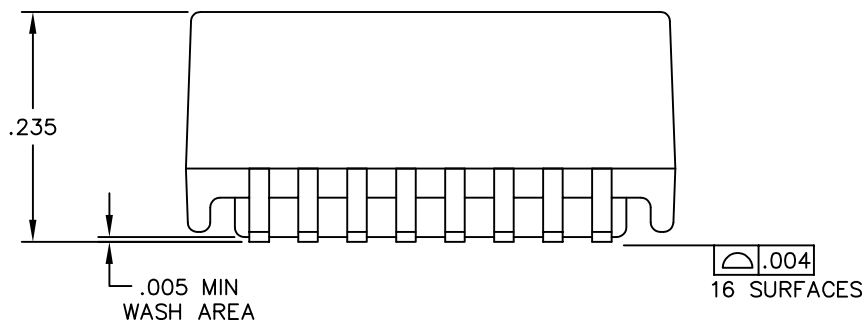

DIMENSIONS ARE IN INCHES WITH THE FOLLOWING TOLERANCES:

.XX= ±.01  
.XXX= ±.005

© Copyright, 2016. Pulse Electronics Corp. All rights reserved. Pulse confidential & proprietary. (09/05/16)

PRODUCT DESCRIPTION  
MDL,SIN,100D,1:1,SM,TU

TLA DRAWING  
HM1188NL-10

PS DRAWING  
PS-2005.001-F

SHEET  
3 OF 3

PART NO.  
HM1188NL

DATASHEET REV.  
E